



www.RedMountainRadio.com

Thanks for your interest in my technical paper. If you find this work to be interesting, or have additional questions, please contact me at the address below. Red Mountain Radio LLC offers professional RF, optical, and microwave design services, and problem solving.

Regards,
Eric Funk, Ph. D.
Partner, Red Mountain Radio LLC
eric@redmountainradio.com
970-325-2158 x12

Background

Wavelength Division Multiplexing (WDM) is
 ... established in digital long-haul telecom
 ... under consideration for microwave fiber-optic systems

- Microwave fiber-optic WDM applications include
- ... Cable TV (< 1 GHz)
 - ... Radio over fiber (to mm wave)
 - ... phased array beam-steering (mm wave)

2

WDM for Fiber Radio and Phased Array Antennas

E. E. Funk, A. L. Campillo, and D. A. Tulchinsky
 Naval Research Laboratory, Washington DC

1

WDM simplifies radio-over-fiber architecture

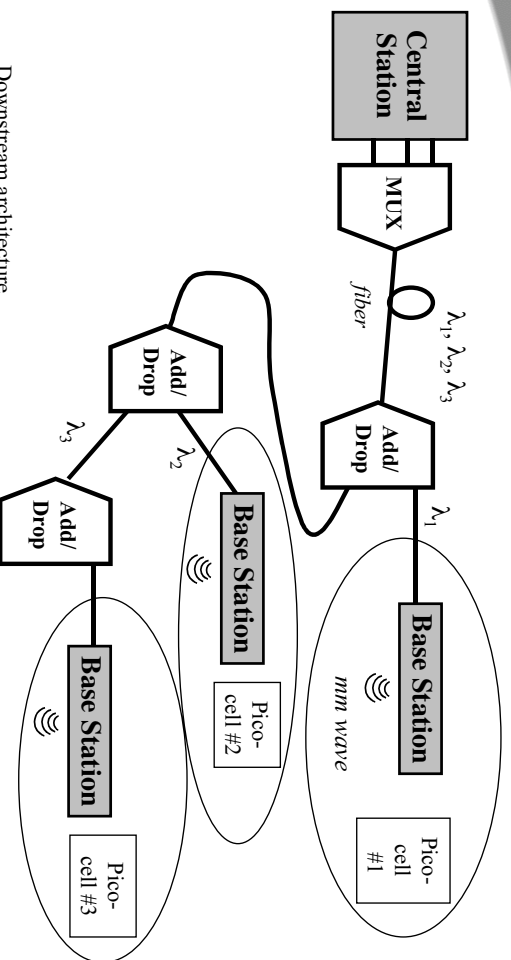

Downstream architecture

3

WDM improves phased array performance

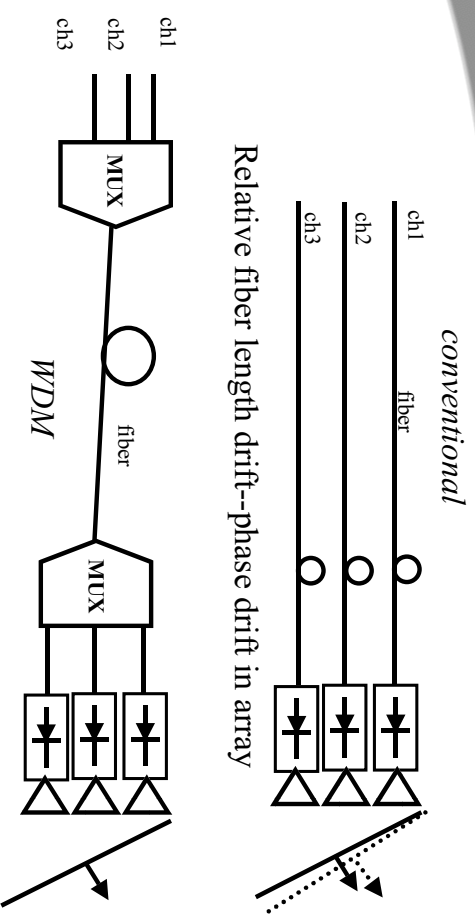

WDM minimizes inter-channel drift--accurate beam forming

4

WDM cross-talk impairments

Causes of WDM cross-talk

- Simulated Raman Scattering (SRS)
- Cross Phase Modulation (XPM)
- Poor filtering in MUX

Effects of WDM cross-talk

- radio-over-fiber systems
- reduced carrier to interference ratio
- BER degradation
- phased array beam-steering systems
- amplitude/phase beam forming errors
- poor side-lobe suppression
- beam pointing errors

5

Stimulated Raman Scattering (SRS) dominant below 1 GHz

- Dominant impairment at CATV frequencies
- Increases with wavelength spacing (up to 100 nm)
- Decreases with modulation frequency
- Decreases with fiber dispersion

Theoretical model based on the following:
 M. R. Phillips, "Cross-talk due to optical fiber nonlinearities in WDM CATV lightwave systems," *J. Lightwave Tech.*, Vol 17, p 1782-1792, 1999.

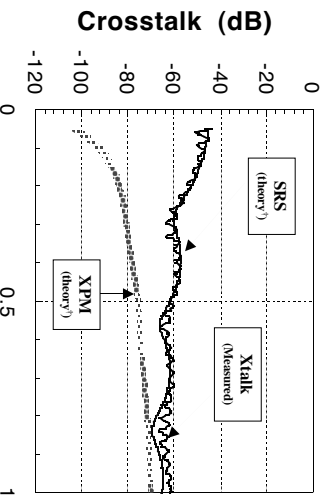

Conventional SMF, 22.3 km, 9.49 nm, 9 dBm

λ_1 :	1558.66	nm	Un-modulated Wavelength
λ_2 :	1549.17	nm	Modulated wavelength
D:	17.00	ps/nm km	Fiber Dispersion
P ₂ :	9	dBm	Modulated Ch. Power
Z:	22.30	km	Fiber Length

7

WDM cross-talk measurement setup

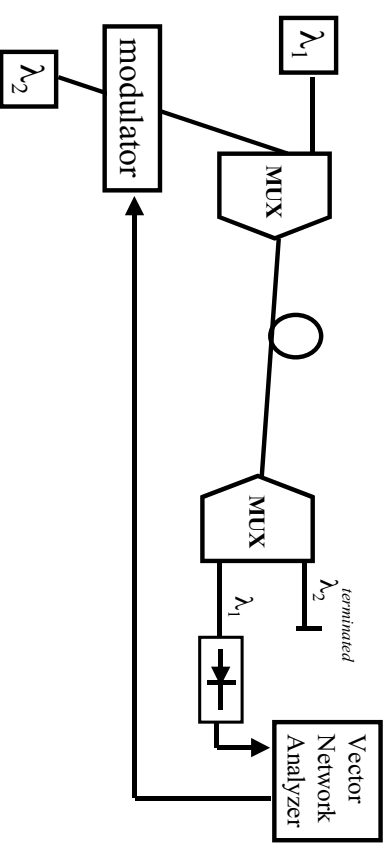

6

Cross-Phase Modulation (XPM) dominant at microwave frequencies

- XPM due to nonlinear refractive index.
- Net dispersion converts XPM to AM cross-talk.
- Dispersion management should improve performance.

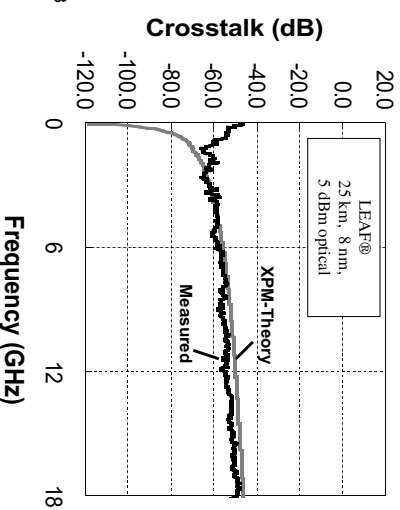
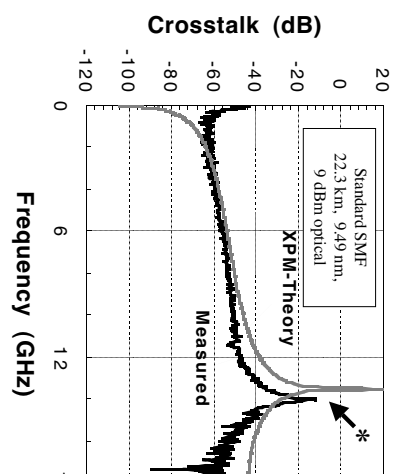

8

* Dispersion induced carrier suppression

Cross-talk will limit long-haul performance

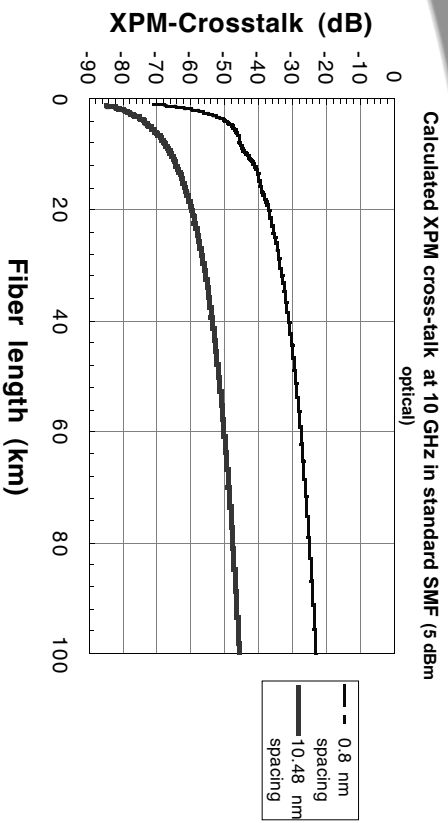

*Does not include carrier suppression from dispersion

9

Cross-talk results in amp. and phase errors

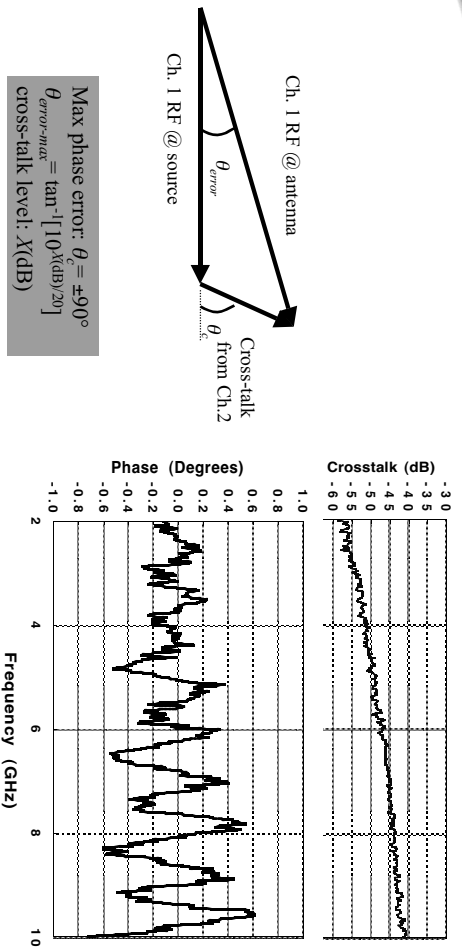

11

Cross-talk phase error measurement

This is an impairment in phased-array systems.

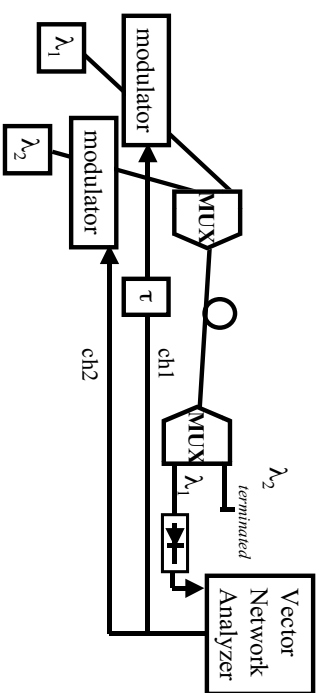

Total delay: 112 μ s
 Differential delay (ch1-ch2): ~ 1 ns
 Standard single mode fiber
 Ch. 1 (Main Channel) = 1549.2 nm
 Ch. 2 (Cross-talk Channel) = 1550.8 nm

10

Summary

- WDM can simplify/improve microwave fiber-optic systems.
- Impairment due to cross-talk must be considered.
- Measurements of cross-talk to 18 GHz performed.
- Results indicate XPM is dominant cross-talk source above 1 GHz.
- Measurements fit theory.
- System design must trade Xtalk w/ launch power, fiber length, etc.

12